

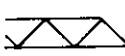





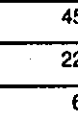

KÖNIG KRAN K 28

SELF - ERECTION CRANE

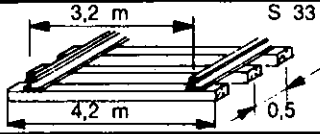
KÖNIG SELF-ERECTION CRANE K 28

	b				b ₃ d				30° b			
	m	kg	m	kg	m	kg	m	kg	m	kg	m	kg
24 m	24	1000	12,53	2300					21	1000	11,1	2300
					24	900	9,93	3000				
	45 m/min – 1000 kg				22,5 m/min – 2000 kg				45 m/min		10,3 KW	
	22,5 m/min – 2300 kg				11,25 m/min – 3000 kg				22,5 m/min		10,3 KW	
	6 m/min – 2300 kg				3 m/min – 3000 kg				6 m/min		2,7 KW	
	30 m/min		1,5 KW		380 V				 3,2 m S 33 4,2 m 0,5			
	30 m/min		2 x 1,8 KW									
	0,33 - 1 u/min		2,2/075 KW		 Gesamtanschlußwert 17,6 KW							

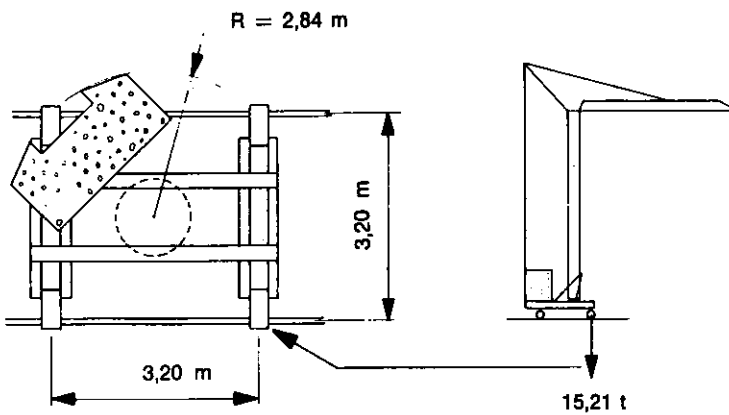

... besser gleich KÖNIG-KRANE

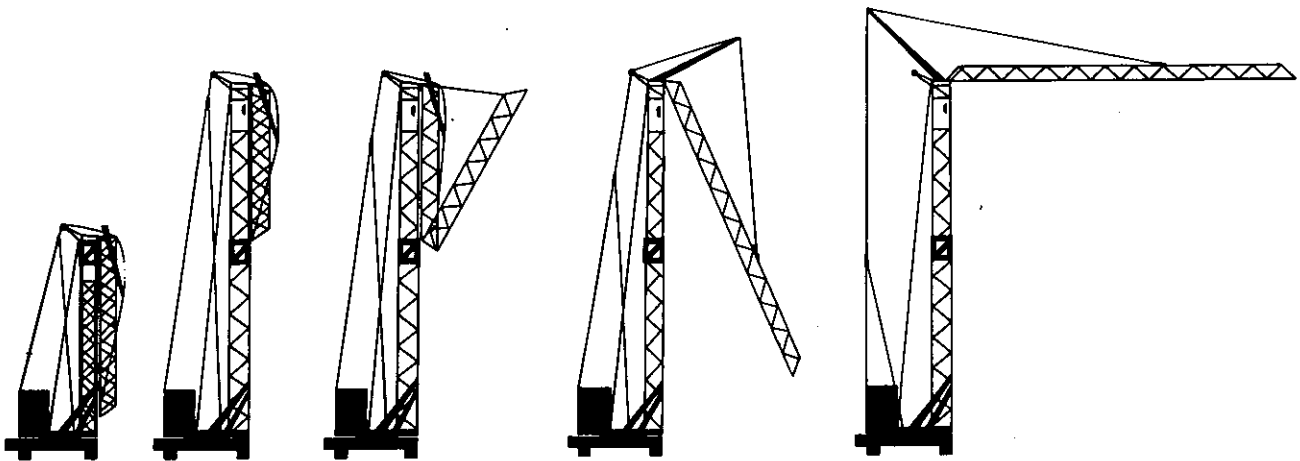

KÖNIG Baumaschinen-Vertrieb GmbH · 53567 ASBACH/Ww. · Telefon: 0 26 83 / 44 36 + 44 37 · Telefax: 4 33 38

